

AUSTRALIAN PRODUCT INFORMATION

Buvidal® Monthly

(buprenorphine)

SOLUTION FOR INJECTION

WARNINGS

Risk of Serious Harm or Death with Intravenous Administration

Serious harm or death could result if administered intravenously. Buvidal Monthly forms a gel depot upon contact with body fluids and may cause occlusion, local tissue damage and thrombo-embolic events, including life threatening pulmonary emboli, if administered intravenously.

Hazardous and harmful use

Although Buvidal Monthly is indicated for the treatment of opioid dependence it still poses risks of hazardous and harmful use which can lead to overdose and death. Monitor the patient's ongoing risk of hazardous and harmful use regularly during opioid substitution therapy with Buvidal Monthly (see section 4.4. *Special Warnings and Precautions for Use*).

Life threatening respiratory depression

Serious, life-threatening or fatal respiratory depression may occur with the use of Buvidal Monthly. Be aware of situations which increase the risk of respiratory depression, and monitor patients closely, especially on initiation or following a dose increase (see section 4.4 *Special Warnings and Precautions for Use*).

Concomitant use of benzodiazepines and other central nervous system (CNS) depressants, including alcohol

Concomitant use of opioids with benzodiazepines, gabapentinoids, antihistamines, tricyclic antidepressants, antipsychotics, cannabis or other central nervous system (CNS) depressants, including alcohol, may result in profound sedation, respiratory depression, coma, and death. Patients and their caregivers should be made aware of the symptoms of respiratory depression. Patients and their caregivers should also be informed of the potential harms of consuming alcohol while taking Buvidal Monthly.

1 NAME OF THE MEDICINE

Buvidal Monthly 64 mg/0.18 mL buprenorphine modified release solution for injection

Buvidal Monthly 96 mg/0.27 mL buprenorphine modified release solution for injection

Buvidal Monthly 128 mg/0.36 mL buprenorphine modified release solution for injection

Buvidal Monthly 160 mg/0.45 mL buprenorphine modified release solution for injection

2 QUALITATIVE AND QUANTITATIVE COMPOSITION

Buvidal Monthly modified release solutions for injection prefilled syringes contain either 64 mg/0.18 mL, 96 mg/0.27 mL, 128/0.36 mL or 160 mg/0.45 mL buprenorphine as the active ingredient.

For Full list of excipients, see section 6.1.

3 PHARMACEUTICAL FORM

Modified release solution for injection.

Yellowish to yellow clear liquid in a pre-filled syringe.

4 CLINICAL PARTICULARS

4.1 THERAPEUTIC INDICATIONS

Buvidal Monthly is indicated for maintenance treatment of opioid dependence with prior stabilisation on Buvidal Weekly or sublingual buprenorphine or buprenorphine/naloxone within a framework of medical, social and psychological support.

4.2 DOSE AND METHOD OF ADMINISTRATION

Administration of Buvidal is restricted to healthcare professionals. Buvidal is given by subcutaneous injection. Buvidal Monthly is indicated for maintenance treatment of patients with opioid dependence in patients who have been stabilised on treatment.

Precautions to be taken before starting treatment

Baseline liver function tests and documentation of viral hepatitis status are recommended prior to commencing therapy. Patients who are positive for viral hepatitis, on concomitant medicinal products (see section 4.5 INTERACTIONS WITH OTHER MEDICINES AND OTHER FORMS OF INTERACTIONS) and/or who have existing liver dysfunction are at greater risk of liver injury. Regular monitoring of the liver function is recommended.

To avoid precipitating symptoms of withdrawal, treatment with Buvidal should be started when objective and clear signs of mild to moderate withdrawal are evident (see section 4.4 SPECIAL WARNINGS AND PRECAUTIONS FOR USE). Consideration should be given to the types of opioid used (that is long- or short-acting opioid), time since last opioid use and the degree of opioid dependence.

- For patients using heroin or short-acting opioids, the initial dose of Buvidal must not be administered until at least 6 hours after the patient last used opioids.
- For patients receiving methadone, the dose of methadone should be reduced to a maximum of 30 mg/day before starting treatment with Buvidal. which should not be administered until at least 24 hours after the patient last received a methadone dose. Buvidal may trigger withdrawal symptoms in methadone-dependent patients

Dosage

Buvidal is indicated for individualised therapy across treatment phases from initiation and stabilisation to maintenance treatment.

The depot administration is used to support treatment adherence and avoid misuse and diversion.

The recommended starting dose is 16 mg of Buvidal Weekly, with one or two additional 8 mg doses at least 1 day apart, to a target dose of 24 mg or 32 mg during the first treatment week. The recommended dose for the second treatment week is the total dose administered during the week of initiation.

Treatment with Buvidal Monthly can be started after treatment initiation with Buvidal Weekly, in accordance with the dose conversion in Table 1 and once patients have been stabilised on weekly treatment.

Transitioning of patients from sublingual buprenorphine to Buvidal Monthly

Patients stabilised on sublingual buprenorphine or buprenorphine/naloxone may be transitioned directly to Buvidal Monthly, starting on the day after the last daily sublingual treatment dose. Please see Table 1 for transition recommendations.

Table 1. Sublingual buprenorphine daily treatment doses and recommended corresponding doses of Buvidal Weekly and Buvidal Monthly

Dose of daily sublingual buprenorphine	Dose of Buvidal Weekly	Dose of Buvidal Monthly
2-6 mg	8 mg	
8-10 mg	16 mg	64 mg
12-16 mg	24 mg	96 mg
18-24 mg	32 mg	128 mg
26-32 mg		160 mg

Maintenance treatment and dose adjustments

Buvidal Monthly should be administered according to individual patient’s needs as well as clinical judgement and at doses established after switching. A maximum of one supplemental Buvidal Weekly 8 mg dose may be administered at an unscheduled visit between the regular monthly doses. The maximum dose per month for patients who are on Buvidal Monthly treatment is 160 mg.

Transitioning patients between Buvidal Weekly and Buvidal Monthly

Patients may be switched from weekly to monthly dosing or from monthly to weekly dosing based on the recommendations in Table 2.

Table 2 Recommended dosing when switching from weekly to monthly dosing or from monthly to weekly dosing

Dose of Buvidal Weekly	Dose of Buvidal Monthly
16 mg	64 mg
24 mg	96 mg
32 mg	128 mg

Switching from Buvidal Monthly to sublingual daily buprenorphine

Treatment with sublingual buprenorphine should be initiated one month after the last dose of Buvidal Monthly according to the recommendations in Table 1.

Missed doses

Dosing windows

To avoid missed doses, the monthly dose may be administered up to 1 week before or after the monthly time point.

Missed doses

If a dose is missed, the next dose should be administered as soon as practical.

Termination of treatment

If Buvidal Monthly treatment is discontinued, its modified release characteristics must be considered.

Method of administration

Buvidal Monthly is intended for subcutaneous use only. It should be injected slowly, into the subcutaneous tissue of the buttock, thigh, abdomen, or upper arm, provided there is sufficient subcutaneous tissue.

Each injection must be administered by a healthcare professional.

The administered dose should be in a single injection and not divided. EACH PRE-FILLED SYRINGE OF BUVIDAL MONTHLY IS FOR SINGLE USE IN ONE PATIENT ONLY. DISCARD ANY RESIDUE.

Parenteral drug products should be inspected visually for particulate matter and discoloration prior to administration, whenever solution and container permit. Do not use Buvidal Monthly prefilled syringes exhibiting particulate matter or discoloration.

Injection sites should be rotated between injections. The dose must not be administered intravascularly or intradermally.

Special Populations

Elderly

The efficacy and safety of buprenorphine in elderly patients > 65 years has not been established.

In general, recommended dosing of Buvidal Monthly for elderly patients with normal renal function is the same as for younger adult patients with normal renal function. However, because elderly patients may have diminished renal/hepatic function, dose adjustment may be necessary (see Renal and Hepatic impairment below).

Hepatic impairment

Buprenorphine should be used with caution in patients with moderate hepatic insufficiency (see section 5.2 PHARMACOKINETIC PROPERTIES). In patients with severe hepatic insufficiency, the use of buprenorphine is contraindicated (see section 4.3 CONTRAINDICATIONS).

Renal impairment

Modification of the buprenorphine dose is not generally required for patients with renal impairment. Caution is recommended when dosing patients with severe renal impairment, who may require dose adjustment (creatinine clearance < 30 ml/min) (see section 5.2 PHARMACOKINETIC PROPERTIES and section 4.4 SPECIAL WARNINGS AND PRECAUTIONS FOR USE).

Paediatric population

The safety and efficacy of Buvidal Monthly in adolescents and children below 16 years of age has not been established. No data are available. (See section 4.4 SPECIAL WARNINGS AND PRECAUTIONS FOR USE and section 4.3 CONTRAINDICATIONS).

4.3 CONTRAINDICATIONS

Hypersensitivity to buprenorphine or to any of the excipients listed in section 6.1.

Children less than 16 years of age

Severe respiratory insufficiency

Severe hepatic insufficiency (Child-Pugh C)

Acute alcoholism or delirium tremens

4.4 SPECIAL WARNINGS AND PRECAUTIONS FOR USE

Administration

Buvidal Monthly is given by subcutaneous injection. Care must be taken to avoid inadvertent injection of Buvidal Monthly as the dose must not be administered intravascularly (intravenously), intramuscularly or intradermally.

Intravenous injection presents significant risk of serious harm or death as Buvidal Monthly forms a gel depot upon contact with body fluids. Occlusion, local tissue damage, and thrombo-embolic events, including life threatening pulmonary emboli, may occur if administered intravenously.

Concomitant use of benzodiazepines and other central nervous system (CNS) depressants, including alcohol

Concomitant use of opioids with benzodiazepines, gabapentinoids, antihistamines, tricyclic antidepressants, antipsychotics, cannabis, tranquilisers, sedatives, hypnotics or other central nervous system (CNS) depressants, including alcohol, may result in profound sedation, respiratory depression, coma, and death (see section 4.5 INTERACTIONS WITH OTHER MEDICINES AND OTHER FORMS OF INTERACTIONS). Patients and their caregivers should be made aware of the symptoms of respiratory depression. Patients and their caregivers should also be informed of the potential harms of consuming alcohol while taking Buvidal Monthly.

General

Opioids may cause orthostatic hypotension in ambulatory patients.

Opioids may elevate cerebrospinal fluid pressure, which may cause seizures. Therefore, opioids should be used with caution in patients with head injury, intracranial lesions, other circumstances where cerebrospinal pressure may be increased, or history of seizure.

Opioids should be used with caution in patients with hypotension, prostatic hypertrophy or urethral stenosis.

Opioid-induced miosis, changes in the level of consciousness or changes in the perception of pain as a symptom of disease may interfere with patient evaluation or obscure the diagnosis or clinical course of concomitant disease.

Opioids should be used with caution in patients with myxoedema, hypothyroidism, or adrenal cortical insufficiency (eg Addison's disease).

Opioids have been shown to increase intracholedochal pressure, and should be used with caution in patients with dysfunction of the biliary tract.

Opioids should be administered with caution to elderly or debilitated patients.

Misuse, abuse and diversion

Buprenorphine is subject to misuse, abuse and diversion, similar to other opioids, legal or illicit. Buvidal Monthly must be administered directly to the patient by a healthcare professional. Buvidal Monthly should not be made available directly to patients. Although Buvidal Monthly is indicated for the treatment of opioid dependence it still poses risks of hazardous and harmful use which can lead to overdose and death. Monitor the patient's ongoing risk of hazardous and harmful use regularly during opioid substitution therapy with Buvidal Monthly.

Respiratory depression

Serious, life-threatening or fatal respiratory depression may occur with the use of Buvidal Monthly. Be aware of situations which increase the risk of respiratory depression, and monitor patients closely, especially on initiation or following a dose increase. A number of cases of death due to respiratory depression have been reported for patients being treated with buprenorphine, particularly when used in combination with benzodiazepines (see section 4.5 INTERACTIONS WITH OTHER MEDICINES AND OTHER FORMS OF INTERACTIONS) or when buprenorphine was not used according to prescribing information. Deaths have also been reported in association with concomitant administration of buprenorphine and other depressants such as alcohol, gabapentinoids (see section 4.5) or other opioids. If buprenorphine is administered to non-opioid dependent individuals who are not tolerant to the effects of opioids, potentially fatal respiratory depression may occur.

Buprenorphine should be used with care in patients with respiratory insufficiency (eg chronic obstructive pulmonary disease, asthma, cor pulmonale, decreased respiratory reserve, hypoxia, hypercapnia, pre-existing respiratory depression or kyphoscoliosis). The use of buprenorphine is contraindicated in patients with severe respiratory insufficiency (see section 4.3 CONTRAINDICATIONS).

Buprenorphine may cause severe, possibly fatal, respiratory depression in children and non-dependent persons who accidentally or deliberately ingest it.

Acute pain management

For management of acute pain during continued use of Buvidal, a combination of opioids with high mu-opioid receptor affinity (e.g. fentanyl), non-opioid analgesics and regional anaesthesia might be necessary. In patients treated with Buvidal Monthly, higher doses of oral or intravenous short-acting opioids (e.g. immediate-release morphine, oxycodone or fentanyl) may be required when titrating to the desired analgesic effect. Patients should be monitored during treatment and caution should be exercised due to the potential risk of overdose and/or death.

Dependence

Buprenorphine is a partial agonist at the μ (μ)-opioid receptor and chronic administration can produce opioid dependence. Studies in animals, as well as clinical experience, have demonstrated that buprenorphine may cause dependence, albeit at a lower level than a full agonist (eg morphine).

Precipitation of opioid withdrawal syndrome

When initiating treatment with buprenorphine, it is important to be aware of the partial agonist profile of buprenorphine. Buprenorphine products have caused precipitated withdrawal symptoms in opioid-dependent patients when administered before the agonist effects resulting from recent opioid use or misuse have subsided. To avoid precipitated withdrawal, induction must be undertaken when objective signs and symptoms of mild to moderate withdrawal are evident (see section 4.2 DOSE AND METHOD OF ADMINISTRATION).

Discontinuation of treatment may result in a withdrawal syndrome that may be delayed in onset.

Hepatitis and hepatic events

Cases of acute hepatic injury have been reported in opioid-dependent patients both in clinical trials and in post-marketing adverse reaction reports with buprenorphine products. The spectrum of abnormalities ranges from transient asymptomatic elevations in hepatic transaminases to case reports of cytolytic hepatitis, hepatic failure, hepatic necrosis, hepatorenal syndrome, hepatic encephalopathy and death. In many cases, the presence of pre-existing liver enzyme abnormalities, genetic disease, infection with hepatitis B or hepatitis C virus, alcohol abuse, anorexia, concomitant use of other potentially hepatotoxic drugs and ongoing injecting drug use may have a causative or contributory role. These underlying factors must be taken into consideration before prescribing buprenorphine and during treatment. When a hepatic event is suspected, further biological and etiological evaluation is required. Depending on the findings, Buprenorphine may be discontinued. If treatment is continued, hepatic function should be monitored closely.

Use in hepatic impairment

Buprenorphine is extensively metabolised in the liver. The effects of hepatic impairment on the pharmacokinetics of buprenorphine were evaluated in a post-marketing study on another marketed buprenorphine product. Plasma levels of buprenorphine were found to be higher in patients with moderate and severe hepatic impairment. Patients should be monitored for signs and symptoms of toxicity or overdose caused by increased levels of buprenorphine. Buprenorphine should be used with caution in patients with moderate hepatic impairment, and dose adjustment may be required (see section 5.2 PHARMACOKINETIC PROPERTIES and section 4.2 DOSE AND METHOD OF ADMINISTRATION). The use of buprenorphine is contraindicated in patients with severe hepatic insufficiency (see section 4.3 CONTRAINDICATIONS).

Use in renal impairment

Renal elimination plays a relatively small role (approximately 30%) in the overall clearance of buprenorphine; therefore, no dose modification based on renal function is generally required. Metabolites of buprenorphine accumulate in patients with renal failure. Caution is recommended when dosing patients with severe renal impairment (creatinine clearance < 30 ml/min), (see section 5.2 PHARMACOKINETIC PROPERTIES and section 4.2 DOSE AND METHOD OF ADMINISTRATION).

Use in the elderly

No data available.

Paediatric use

The safety and efficacy of buprenorphine in children below the age of 16 years have not been established. Due to the limited amount of data in adolescents (from 16 up to 18 years), patients in this age group should be more closely monitored during treatment.

Neonatal Abstinence Syndrome

Buprenorphine should be used during pregnancy only if the potential benefit outweighs the potential risk to the fetus. Chronic use of buprenorphine by the mother at the end of pregnancy may result in a withdrawal syndrome (e.g. hypertonia, neonatal tremor, neonatal agitation, myoclonus, convulsions, apnoea or bradycardia) in the neonate. In many reported cases, withdrawal was serious and required treatment. The syndrome is generally delayed for several hours to several days after birth (see Section 4.6 USE IN PREGNANCY).

Allergic reactions

Cases of acute and chronic hypersensitivity to buprenorphine have been reported. The most common signs and symptoms include rashes, hives and pruritis. Cases of bronchospasm, angioneurotic oedema, and anaphylactic shock have been reported. A history of hypersensitivity to buprenorphine is a contraindication to Buvidal Monthly.

Effects on laboratory tests

Athletes should be aware that this medicine may cause a positive reaction to “anti-doping” tests.

4.5 INTERACTIONS WITH OTHER MEDICINES AND OTHER FORMS OF INTERACTIONS

No interaction studies have been performed with Buvidal Monthly.

Buprenorphine should be used cautiously when co-administered with:

- benzodiazepines: this combination may result in death due to respiratory depression of central origin. Therefore, dosages must be closely monitored, and this combination must be avoided in cases where there is a risk of misuse. Patients should be warned that it is extremely dangerous to self-administer non-prescribed benzodiazepines whilst taking this product and should also be cautioned to use benzodiazepines concurrently with this product only as directed by their doctor (see section 4.4 SPECIAL WARNINGS AND PRECAUTIONS FOR USE).
- gabapentinoids: this combination may result in death due to respiratory depression. Therefore, dosages must be closely monitored and this combination must be avoided in cases where there is a risk of misuse. Patients should be cautioned to use gabapentinoids (such as pregabalin and gabapentin) concurrently with this product only as directed by their physician (see section 4.4).
- alcoholic drinks or medications containing alcohol as alcohol increases the sedative effect of buprenorphine (see section 4.4 SPECIAL WARNINGS AND PRECAUTIONS FOR USE).
- other central nervous system depressants: other opioid derivatives (eg methadone, analgesics and antitussives); certain antidepressants, antihistamines (eg sedating H₁-receptor antagonists), barbiturates, anxiolytics other than benzodiazepines, cannabis, neuroleptics, clonidine and related substances. These combinations increase central nervous

system depression. The reduced level of alertness can make driving and using machinery hazardous (see section 4.4 SPECIAL WARNINGS AND PRECAUTIONS FOR USE).

- opioid analgesics: adequate analgesia may be difficult to achieve when administering a full opioid agonist in patients receiving buprenorphine. The potential for overdose also exists with a full agonist, especially when attempting to overcome buprenorphine partial agonist effects, or when buprenorphine plasma levels are declining (see section 4.4 SPECIAL WARNINGS AND PRECAUTIONS FOR USE).
- naltrexone and nalmefene: these opioid antagonists can block the pharmacological effects of buprenorphine. For opioid-dependent patients currently receiving buprenorphine treatment, naltrexone may precipitate a sudden onset of prolonged and intense opioid withdrawal symptoms. For patients currently receiving naltrexone treatment, the intended therapeutic effects of buprenorphine administration may be blocked by naltrexone.
- CYP3A4 inhibitors: an interaction study of buprenorphine with ketoconazole (a potent inhibitor of CYP3A4) resulted in increased C_{max} (approximately 50%) and AUC (approximately 70%) of buprenorphine and, to a lesser extent, of the metabolite, norbuprenorphine. Patients receiving buprenorphine should be closely monitored and may require dose reduction if combined with potent CYP3A4 inhibitors (eg protease inhibitors like ritonavir, nelfinavir or indinavir, or azole antifungals such as ketoconazole or itraconazole, or macrolide antibiotics).
- CYP3A4 inducers: Concomitant use of CYP3A4 inducers with buprenorphine may decrease buprenorphine plasma concentrations, potentially resulting in sub-optimal treatment of opioid dependence with buprenorphine. It is recommended that patients receiving buprenorphine should be closely monitored if inducers (eg phenobarbital, carbamazepine, phenytoin or rifampicin) are co-administered. The dose of either buprenorphine or the CYP3A4 inducer may need to be adjusted accordingly.
- monoamine oxidase inhibitors (MAOI): possible exacerbation of the opioid effects, based on experience with morphine.
- Serotonergic medicinal products, such as MAO inhibitors, selective serotonin re-uptake inhibitors, serotonin noradrenaline (norepinephrine) re-uptake inhibitors, or tricyclic antidepressants as the risk of serotonin syndrome, a rare but potentially life-threatening condition, is increased.

4.6 FERTILITY, PREGNANCY AND LACTATION

Effects on fertility

There are no or limited data on effects of buprenorphine on human fertility.

An effect of buprenorphine on fertility in animals has not been seen.

There were no effects on mating performance or on fertility of male rats following short term treatment with buprenorphine at systemic exposures up to 38 times the maximum anticipated human exposure (based on plasma AUC).

Use in pregnancy – Pregnancy Category C

There are no or limited data from the use of buprenorphine in pregnant women.

Buprenorphine readily crosses the placental barrier. Treatment with buprenorphine during pregnancy was associated with difficult parturition and fetotoxicity, including post-implantation loss and decreased postnatal survival, in rats and rabbits at systemic exposures higher than the maximum anticipated human exposure of buprenorphine by Buvidal Monthly. Teratology toxicity

studies in rats by intramuscular administration concluded that buprenorphine is not embryotoxic or teratogenic and has no marked effects on weaning potential. Maternal oral administration at high doses (80 mg/kg/day) during gestation and lactation resulted in delayed postnatal development of some neurological functions (surface righting reflex and startle response) in neonatal rats with NOEL of 8 mg/kg/day PO.

Buprenorphine should be used during pregnancy only if the potential benefit outweighs the potential risk to the fetus.

Towards the end of pregnancy, buprenorphine may induce respiratory depression in the newborn infant even after a short period of administration. Long-term administration during the last three months of pregnancy may cause a withdrawal syndrome in the neonate (e.g. hypertonia, neonatal tremor, neonatal agitation, myoclonus or convulsions). The syndrome is generally delayed from several hours to several days after birth.

Due to the long half-life of buprenorphine, neonatal monitoring for several days after birth should be considered to prevent the risk of respiratory depression or withdrawal syndrome in neonates.

Use in lactation.

Animal studies indicate buprenorphine has the potential to inhibit lactation or milk production. Decreases in postnatal survival, growth and development were also observed in animals treated with buprenorphine during lactation.

Buprenorphine and its metabolites are excreted in human breast milk and Buvidal should be used with caution during breast-feeding.

4.7 EFFECTS ON ABILITY TO DRIVE AND USE MACHINES

Buprenorphine has moderate influence on the ability to drive and use machines when administered to opioid-dependent patients. Buprenorphine may cause drowsiness, dizziness or impaired thinking, especially during treatment induction and dose adjustment. If taken together with alcohol or central nervous system depressants, the effect is likely exaggerated (see section 4.4 SPECIAL WARNINGS AND PRECAUTIONS FOR USE) and section 4.5 INTERACTIONS WITH OTHER MEDICINES AND OTHER FORMS OF INTERACTIONS). Patients should be cautioned about operating hazardous machinery in case buprenorphine may affect their ability to engage in such activities.

4.8 ADVERSE EFFECTS (UNDESIRABLE EFFECTS)

The adverse events most frequently reported in the double-blind, pivotal phase 3 efficacy clinical trial were constipation, symptoms commonly associated with drug withdrawal, such as headache, nausea, insomnia and vomiting, injection site related events such as injection site pain, injection site pruritus and injection site erythema, urinary tract infection and upper respiratory tract infection.

Table 3 provides a summary of Treatment-Emergent Adverse Events (TEAEs) reported for at least 1% of patients in either treatment group by System Organ Class and Preferred Term (HS-11-421 safety population).

The pattern of TEAEs and serious adverse events (SAEs) was comparable between treatment groups and was consistent with the safety profile of SL BPN.

Overall in study HS-11-421, 247 subjects (57.7%) experienced at least 1 TEAE during the study (119 [55.3%], SL BPN/NX; 128 [60.1%], Buvidal), and 88 (20.6%) subjects had at least 1 injection site TEAE

(48 [22.3%], SL BPN/NX; 40 [18.8%], Buvidal). Approximately 30% of all subjects had at least 1 study drug-related TEAE (18.0%, injection site TEAE; 18.0%, non-injection site TEAE).

Overall (across both treatment groups), the most common TEAEs (regardless of drug attribution) were injection site pain (8.4%), headache (7.7%), constipation (7.5%), nausea (7.5%), injection site pruritus (6.1%), and injection site erythema (5.6%). Other injection site TEAEs that occurred in >1% of all subjects were injection site reaction (3.5%), injection site swelling (3.5%), injection site induration (2.3%), injection site inflammation (2.3%), injection site bruising (1.2%) and injection site ulcer (1.2%).

Incidences of injection site TEAEs were generally comparable between treatment groups, ie, after injection of active Buvidal or placebo Buvidal. The incidence of injection site inflammation was slightly higher in the SL BPN/NX group (3.7%) than in the Buvidal group (0.9%). Injection site TEAEs, which were generally characterised as injection site pain, pruritus, and erythema, were all mild or moderate in intensity, with most being mild.

Table 3 Summary of Treatment-Emergent Adverse Events Reported for at Least 1% of Patients in Either Treatment Group by System Organ Class and Preferred Term (HS-11-421 safety population).

SYSTEM ORGAN CLASS	PREFERRED TERM	SL BPN (N=215)	BUVIDAL (N=213)	TOTAL (N=428)
At least one AE		119 (55.3%)	128 (60.1%)	247 (57.7%)
Cardiac disorders				
	Tachycardia	5 (2.3%)	5 (2.3%)	10 (2.3%)
Ear and labyrinth disorders				
	Ear pain	1 (0.5%)	3 (1.4%)	4 (0.9%)
Gastrointestinal disorders				
	Abdominal pain	3 (1.4%)	1 (0.5%)	4 (0.9%)
	Abdominal pain upper	3 (1.4%)	2 (0.9%)	5 (1.2%)
	Constipation	16 (7.4%)	16 (7.5%)	32 (7.5%)
	Diarrhoea	7 (3.3%)	6 (2.8%)	13 (3.0%)
	Nausea	17 (7.9%)	15 (7.0%)	32 (7.5%)
	Toothache	8 (3.7%)	3 (1.4%)	11 (2.6%)
	Vomiting	8 (3.7%)	9 (4.2%)	17 (4.0%)
General disorders and administration site conditions				
	Drug withdrawal syndrome	3 (1.4%)	0 (0.0%)	3 (0.7%)
	Fatigue	4 (1.9%)	2 (0.9%)	6 (1.4%)
	Injection site bruising	4 (1.9%)	1 (0.5%)	5 (1.2%)
	Injection site erythema	12 (5.6%)	12 (5.6%)	24 (5.6%)
	Injection site induration	6 (2.8%)	4 (1.9%)	10 (2.3%)
	Injection site inflammation	8 (3.7%)	2 (0.9%)	10 (2.3%)
	Injection site mass	1 (0.5%)	3 (1.4%)	4 (0.9%)
	Injection site pain	17 (7.9%)	19 (8.9%)	36 (8.4%)
	Injection site pruritus	13 (6.0%)	13 (6.1%)	26 (6.1%)
	Injection site reaction	7 (3.3%)	8 (3.8%)	15 (3.5%)
	Injection site swelling	6 (2.8%)	9 (4.2%)	15 (3.5%)
	Injection site ulcer	3 (1.4%)	2 (0.9%)	5 (1.2%)
	Oedema peripheral	3 (1.4%)	2 (0.9%)	5 (1.2%)
	Pyrexia	3 (1.4%)	3 (1.4%)	6 (1.4%)
Infections and infestations				
	Cellulitis	7 (3.3%)	1 (0.5%)	8 (1.9%)
	Gastroenteritis	3 (1.4%)	2 (0.9%)	5 (1.2%)

SYSTEM ORGAN CLASS	PREFERRED TERM	SL BPN (N=215)	BUVIDAL (N=213)	TOTAL (N=428)
	Gastroenteritis viral	3 (1.4%)	1 (0.5%)	4 (0.9%)
	Nasopharyngitis	2 (0.9%)	4 (1.9%)	6 (1.4%)
	Oral herpes	1 (0.5%)	3 (1.4%)	4 (0.9%)
	Pneumonia	4 (1.9%)	1 (0.5%)	5 (1.2%)
	Subcutaneous abscess	3 (1.4%)	0 (0.0%)	3 (0.7%)
	Tooth abscess	3 (1.4%)	3 (1.4%)	6 (1.4%)
	Upper respiratory tract infection	9 (4.2%)	9 (4.2%)	18 (4.2%)
	Urinary tract infection	10 (4.7%)	11 (5.2%)	21 (4.9%)
	Viral infection	3 (1.4%)	2 (0.9%)	5 (1.2%)
Injury, poisoning and procedural complications				
	Accidental overdose	4 (1.9%)	0 (0.0%)	4 (0.9%)
	Laceration	3 (1.4%)	4 (1.9%)	7 (1.6%)
Investigations				
	Alanine aminotransferase increased	4 (1.9%)	4 (1.9%)	8 (1.9%)
	Aspartate aminotransferase increased	4 (1.9%)	4 (1.9%)	8 (1.9%)
	Blood glucose increased	3 (1.4%)	1 (0.5%)	4 (0.9%)
	Gamma-glutamyltransferase increased	3 (1.4%)	2 (0.9%)	5 (1.2%)
	Weight decreased	3 (1.4%)	3 (1.4%)	6 (1.4%)
Musculoskeletal and connective tissue disorders				
	Arthralgia	3 (1.4%)	7 (3.3%)	10 (2.3%)
	Back pain	6 (2.8%)	3 (1.4%)	9 (2.1%)
	Muscle spasms	3 (1.4%)	3 (1.4%)	6 (1.4%)
	Musculoskeletal pain	5 (2.3%)	0 (0.0%)	5 (1.2%)
	Neck pain	1 (0.5%)	3 (1.4%)	4 (0.9%)
	Pain in extremity	2 (0.9%)	4 (1.9%)	6 (1.4%)
Nervous system disorders				
	Dizziness	2 (0.9%)	3 (1.4%)	5 (1.2%)
	Headache	17 (7.9%)	16 (7.5%)	33 (7.7%)
	Hypoaesthesia	0 (0.0%)	4 (1.9%)	4 (0.9%)
Psychiatric disorders				
	Anxiety	7 (3.3%)	6 (2.8%)	13 (3.0%)

SYSTEM ORGAN CLASS	PREFERRED TERM	SL BPN (N=215)	BUVIDAL (N=213)	TOTAL (N=428)
	Depression	2 (0.9%)	3 (1.4%)	5 (1.2%)
	Insomnia	6 (2.8%)	12 (5.6%)	18 (4.2%)
	Libido decreased	3 (1.4%)	0 (0.0%)	3 (0.7%)
Respiratory, thoracic and mediastinal disorders				
	Cough	2 (0.9%)	4 (1.9%)	6 (1.4%)
	Nasal congestion	0 (0.0%)	3 (1.4%)	3 (0.7%)
Skin and subcutaneous tissue disorders				
	Hyperhidrosis	3 (1.4%)	1 (0.5%)	4 (0.9%)

Table 4 Summary of Uncommon (<1%) Adverse Reactions observed in the pivotal phase 3 efficacy clinical trial (HS-11-421 safety population listed by body system

System Organ Class	Uncommon ($\geq 1/1000$ to $< 1/100$)
Infections and infestations	Injection site cellulitis
Psychiatric disorders	Anxiety
Nervous system disorders	Dizziness Sedation Somnolence
Ear and labyrinth disorders	Vertigo
Gastrointestinal disorders	Diarrhoea Dry mouth
Hepatobiliary disorders	Alanine aminotransferase increased Aspartate aminotransferase increased Hepatic enzymes increased
Skin and subcutaneous tissue disorders	Rash macular
Musculoskeletal and connective tissue disorders	Arthralgia
General disorders and administration site conditions	Injection site inflammation Injection site bruising Injection site urticaria Oedema peripheral
Injury, poisoning and procedural complications	Procedural dizziness

Adverse reactions reported with buprenorphine

The following adverse reactions have been reported with the use of buprenorphine products and may occur with Buvidal Monthly.

Very common: Insomnia, headache, nausea, hyperhidrosis, drug withdrawal syndrome, and pain.

Common: Bronchitis, infection, influenza, pharyngitis, rhinitis, lymphadenopathy, decreased appetite, agitation, anxiety, depression, hostility, nervousness, paranoia, thinking abnormal,

dizziness, hypertonia, migraine, paraesthesia, somnolence, syncope, tremor, lacrimal disorder, mydriasis, palpitations, vasodilatation, cough, dyspnoea, yawning, abdominal pain, constipation, diarrhoea, dry mouth, dyspepsia, gastrointestinal disorder, flatulence, vomiting, rash, arthralgia, back pain, bone pain, muscle spasms, myalgia, neck pain, dysmenorrhoea, asthenia, chest pain, chills, malaise, oedema peripheral and pyrexia.

In addition, hallucination, urinary retention and vertigo have been reported with the use of buprenorphine products.

Post-marketing experience

Injection site-related adverse reactions of abscess, ulceration and necrosis have been reported during post-marketing use with Buvidal (with frequency not known).

Reporting suspected adverse effects

Reporting suspected adverse reactions after registration of the medicinal product is important. It allows continued monitoring of the benefit-risk balance of the medicinal product. Healthcare professionals are asked to report any suspected adverse reactions at www.tga.gov.au/reporting-problems.

4.9 OVERDOSE

Symptoms

Respiratory depression, as a result of central nervous system depression, is the primary symptom requiring intervention in the case of buprenorphine overdose because it may lead to respiratory arrest and death. Preliminary symptoms of overdose may also include excessive sweating, somnolence, amblyopia, miosis, hypotension, nausea, vomiting and / or speech disorders.

Treatment

General supportive measures should be instituted, including close monitoring of respiratory and cardiac status of the patient. Symptomatic treatment of respiratory depression, following standard intensive care measures, should be instituted. A patent airway and assisted or controlled ventilation must be assured. The patient should be transferred to an environment within which full resuscitation facilities are available. If the patient vomits, precautions must be taken to prevent aspiration. Use of an opioid antagonist (ie naloxone) is recommended, despite the modest effect it may have in reversing the respiratory symptoms of buprenorphine compared with its effects on full agonist opioid agents.

The long duration of action of buprenorphine and the modified release from Buvidal Monthly, should be taken into consideration when determining length of treatment needed to reverse the effects of an overdose. Naloxone can be cleared more rapidly than buprenorphine, allowing for a return of previously controlled buprenorphine overdose symptoms.

For information on the management of overdose, contact the Poisons Information Centre on 131126 (Australia) for advice.

5 PHARMACOLOGICAL PROPERTIES

5.1 PHARMACODYNAMIC PROPERTIES

Mechanism of action

Buprenorphine is a high-affinity partial agonist at the human μ (mu) opioid receptor and is a high-affinity antagonist at the δ (delta) and κ (kappa) opioid receptors, as well as being a moderate-affinity partial agonist for nociception opioid receptors.

Its activity in opioid maintenance treatment is attributed to its slowly reversible properties with the μ -opioid receptors which, over a prolonged period, might minimise the need of illicit opioids for patients with opioid dependence.

Opioid agonist ceiling effects were observed during clinical pharmacology studies in opioid-dependent persons.

Pharmacodynamic effects

The blockade of subjective opioid effects of Buvidal Weekly was investigated in a multiple-dose, opioid challenge study in 47 patients with moderate to severe opioid dependence. After stabilisation on immediate-release morphine, all patients completed a 3-day qualification/baseline hydromorphone challenge session, which included intramuscular administration of 3 doses of hydromorphone (0 mg [placebo], 6 mg and 18 mg) once daily for 3 consecutive days in a randomised, double-blind, crossover manner. Following the qualification phase, eligible patients received 2 randomised doses of 24 mg or 32 mg Buvidal Weekly. Two hydromorphone challenge sessions (3 consecutive days each) were conducted after each dose of Buvidal Weekly.

The primary endpoint was maximum rating (E_{max}) on the visual analogue scale (VAS) for drug liking. During the qualification/baseline phase, patients could differentiate between hydromorphone 6 mg or 18 mg and placebo and showed an appropriate hydromorphone dose response (ie increase in drug liking E_{max} with increasing dose of hydromorphone). Minimal differences in E_{max} scores were observed between placebo and hydromorphone 6 mg or 18 mg during the hydromorphone challenge sessions performed after each administration of 24 mg or 32 mg Buvidal Weekly. The pre-defined upper bound of the 95% confidence interval (CI) for complete blockade of drug liking was 11 mm VAS E_{max} between hydromorphone doses and placebo. Complete blockade (i.e. VAS $E_{max} \leq 11$ mm between hydromorphone and placebo injections) was observed at all challenge sessions with both doses of weekly Buvidal.

Secondary VAS E_{max} measures (including high, good drug effects, any drug effects, and desire to use) were also blocked or suppressed by both weekly doses.

Clinical trials

Clinical efficacy

Study HS-11-421: The efficacy and safety of Buvidal in the treatment of opioid dependence were established in a pivotal phase 3, randomised, double-blind, double-dummy, active-controlled, flexible-dose study in patients with moderate to severe opioid dependence who were not currently participating in opioid substitution treatment. In this study, 428 patients were randomised to one of two treatment groups. Patients in the Buvidal group (n = 213) received weekly injections (16 mg to 32 mg) at the clinic during the first 12 weeks, followed by monthly injections (64 mg to 160 mg)

during the last 12 weeks, plus daily take-home doses of sublingual placebo tablets during the complete treatment period. Patients in the sublingual buprenorphine/naloxone group (n = 215) received weekly placebo injections at the clinic during the first 12 weeks, followed by monthly placebo injections during the last 12 weeks, plus daily take-home sublingual buprenorphine/naloxone tablets during the complete treatment period (8 mg to 24 mg during the first 12 weeks and 8 mg to 32 mg during the last 12 weeks). During the 12 weeks with monthly injections, patients in both groups could receive one additional 8 mg weekly dose of Buvidal Weekly per month, if needed. Patients attended 12 weekly visits during the first 12 weeks and 6 visits during the last 12 weeks (3 scheduled monthly visits and 3 random urine toxicology visits). At each visit, efficacy and safety outcome measures were assessed. The primary endpoint of the study was to demonstrate non-inferiority in mean percentage of urine samples negative for illicit opioids during treatment weeks 1 to 24 for the Buvidal group compared with the sublingual buprenorphine/naloxone group. Non-inferiority was to be concluded if the lower limit of the two-sided 95% confidence interval (CI) for the difference (Buvidal and sublingual buprenorphine/naloxone) in percent negative urine samples was above -11%.

The study met the primary endpoint of non-inferiority in mean percentage of urine samples negative for illicit opioids (p < 0.001). The Least Squares mean (95% CI) was 35.1% (30.3%, 40.0%) in the Buvidal group and 28.4% (23.5%, 33.3%) in the sublingual buprenorphine/naloxone group. The difference between treatment groups was 6.7% (Buvidal vs sublingual buprenorphine/naloxone) with a 95% CI of -0.1%, 13.6%. Figure 1 shows percentage of patients with urine samples negative for illicit opioids over the 24-week treatment period.

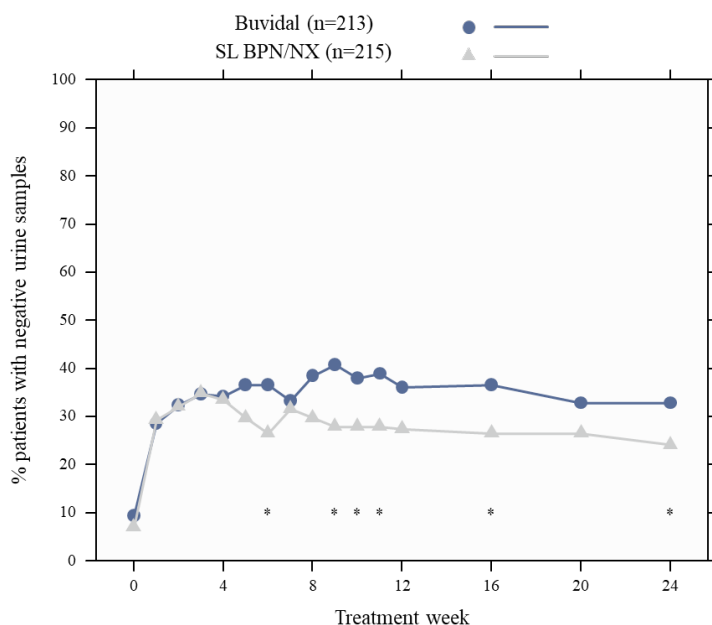

SL BPN/NX=sublingual buprenorphine/naloxone

* p < 0.05 (Chi-square test)

Figure 1 Percent patients with urine samples negative for illicit opioids by assessment time point of urine toxicology samples (missing data imputed as positive).

Superiority of Buvidal versus sublingual buprenorphine/naloxone was met for the secondary endpoint cumulative distribution function (CDF) for percentage of opioid-negative urine samples during treatment weeks 4 to 24. The median CDF was 26.7% for Buvidal and 6.7% for sublingual

buprenorphine/naloxone ($p = 0.008$), Figure 2. A closed testing procedure controlling for overall type 1 error rate (5%, two-sided) with a pre-specified test order was applied, where testing for superiority only was applicable if the primary outcome demonstrated non-inferiority.

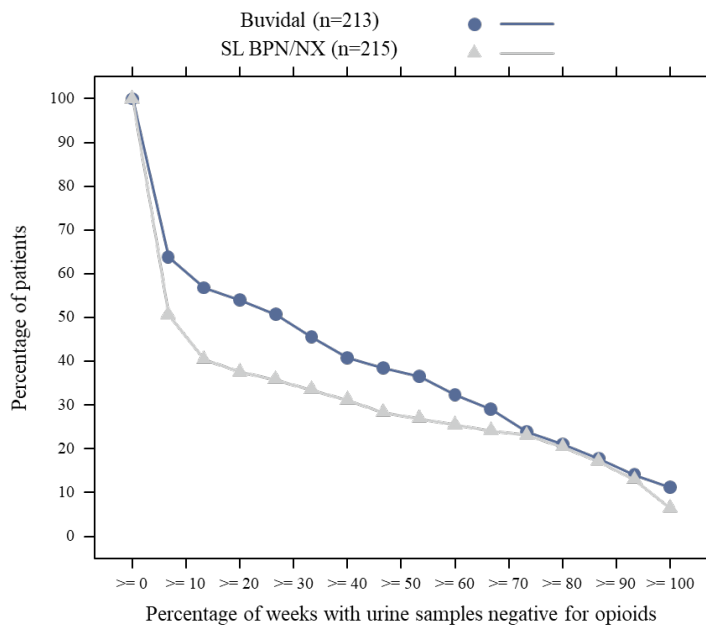

SL BPN/NX=sublingual buprenorphine/naloxone

Figure 2 Cumulative percentage of patients with opioid-negative urine samples for treatment weeks 4 to 24.

When the primary analysis was repeated in a *post hoc* analysis without imputation of missing urine samples, a significant difference between treatment groups of 8.7% (95% CI: 0.9%, 16.4%) was demonstrated for Buvidal compared to sublingual buprenorphine/naloxone ($p = 0.028$). *Post hoc* sensitivity analyses of CDF for urine samples negative for illicit opioids over the full treatment period (weeks 1 to 24) confirmed superiority of Buvidal (median 22.2%) compared to sublingual buprenorphine/naloxone (median 5.6%) ($p = 0.011$).

Of the 428 randomised patients, 69.0% (147/213) of the patients in the Buvidal treatment group and 72.6% (156/215) of the patients in the sublingual buprenorphine/naloxone treatment group completed the 24-week treatment period.

During the first 12 weeks of the study, excluding the first week of initiation, the median Buvidal Weekly dose was 24 mg (range 16 to 32 mg) and the median daily sublingual buprenorphine/naloxone dose was 16 mg (range 8 to 24 mg). During the last 12 weeks of the study, the median Buvidal Monthly dose was 96 mg (range 64 to 160 mg) and the median daily sublingual buprenorphine/naloxone dose was 16 mg (range 8 to 32 mg).

Study HS-14-499: A long-term, open-label, phase 3 safety study with flexible dosing of weekly and monthly Buvidal for 48 weeks was conducted. The study enrolled a total of 227 patients with moderate to severe opioid dependence, of which 190 patients were transferred from sublingual buprenorphine (with or without naloxone), and 37 patients were new to buprenorphine treatment. During the 48-week treatment period, patients could switch between weekly and monthly injections with Buvidal and between doses (8 mg to 32 mg weekly Buvidal and 64 mg to 160 mg monthly Buvidal) according to the physician's clinical judgement. The mean duration of treatment with

Buvidal Weekly was 162.5 days (median 112 days; range 7 to 336 days) and the mean duration of treatment with Buvidal Monthly was 239.6 days (median 280 days; range 28 to 336 days). The median doses that the patients were stabilised on were 24 mg Buvidal Weekly (range 16 to 32 mg) or 96 mg Buvidal Monthly (range 64 to 160 mg).

For patients who were transferred from sublingual buprenorphine, the percentage of patients with illicit opioid-negative urine samples was 78.8% at baseline and 84.0% at the end of the 48-week treatment period. For the new-to-treatment patients, the percentage of patients with illicit opioid-negative urine samples was 0.0% at baseline and 63.0% at the end of the 48-week treatment period. Overall, 156 patients (68.7%) completed the 48-week treatment period.

No illicit drug overdoses were reported for the 440 patients treated Buvidal in the two phase 3 studies.

HS-17-585: A randomised, open-label, study comparing flexible dosing of weekly and monthly Buvidal versus buprenorphine standard of care for 24 weeks was conducted. The study enrolled a total of 120 patients with opioid dependence (60 patients per group) to treatment with either Buvidal or standard of care with daily SL BPN. Patients in the Buvidal group could be transitioned between weekly and monthly injections with Buvidal and between doses (8 mg to 32 mg weekly Buvidal and 64 mg to 160 mg monthly Buvidal) according to the physician's clinical judgement. Patients in the standard of care group were allowed dose changes according to the approved product labelling.

Buvidal was shown to result in a higher patient treatment satisfaction compared to buprenorphine standard of care, as measured using the Treatment Satisfaction Questionnaire for Medication (TSQM) global satisfaction score (82.5 versus 74.3 at Week 24).

5.2 PHARMACOKINETIC PROPERTIES

Absorption

Buvidal Monthly is a modified release formulation of buprenorphine designed for administration by subcutaneous injection once a month. After injection, the buprenorphine plasma concentration increases with a median time to maximum plasma concentration (t_{max}) of about 6-10 hours. Buvidal Monthly has complete absolute bioavailability, and a 6 to 9-fold higher bioavailability compared to sublingual buprenorphine. Steady-state exposure is reached at the fourth monthly dose.

Dose-proportional increases in exposure and time-independent pharmacokinetics are observed for Buvidal Monthly (64 mg to 160 mg).

Distribution

Buprenorphine is lipophilic and has a large volume of distribution. Buprenorphine is highly protein bound (96%), primarily to α -(alpha) and β -(beta) globulin.

Metabolism

Buprenorphine is metabolised by N-dealkylation to norbuprenorphine via cytochrome P450 CYP3A4 and both parent molecule and metabolite then undergo glucuronidation. The norbuprenorphine metabolite can show high affinity for and biological activity at opioid receptors.

Subcutaneous administration of Buvidal Monthly results in significantly lower plasma concentrations of norbuprenorphine metabolite compared to administration of sublingual buprenorphine, due to avoidance of first-pass metabolism.

Excretion

The rate of release of buprenorphine from Buvidal Monthly controls its elimination with a terminal half-life in plasma ranging from 19 to 25 days.

Buprenorphine is primarily eliminated in the faeces by biliary excretion of the glucuroconjugated metabolites (70%), the remainder being eliminated in the urine. Total clearance of buprenorphine is approximately 68 L/h.

Special Populations

Elderly

No pharmacokinetic data in elderly patients (> 65 years) are available.

Renal impairment

Renal elimination plays a relatively small role (~30%) in the overall clearance of buprenorphine. No dose modification based on renal function is required, but caution is recommended when dosing subjects with severe renal impairment (see section 4.2 DOSE AND METHOD OF ADMINISTRATION and section 4.4 SPECIAL WARNINGS AND PRECAUTIONS FOR USE).

Hepatic impairment

The effect of hepatic impairment on the pharmacokinetics of buprenorphine and naloxone has been evaluated in a post-marketing study of sublingual buprenorphine. Results are provided in Table 5 below.

Table 5 Effect of hepatic impairment (change relative to healthy subjects) on pharmacokinetic parameters of buprenorphine following sublingual buprenorphine/naloxone administration (2.0/0.5 mg) in healthy subjects, and in subjects with varied degrees of hepatic impairment

Pharmacokinetic Parameter	Mild Hepatic Impairment (Child-Pugh Class A) (n=9)	Moderate Hepatic Impairment (Child-Pugh Class B) (n=8)	Severe Hepatic Impairment (Child-Pugh Class C) (n=8)
Buprenorphine			
C _{max}	1.2-fold increase	1.1-fold increase	1.7-fold increase
AUC _{last}	Similar to control	1.6-fold increase	2.8-fold increase

Overall, buprenorphine plasma exposure increased approximately 3-fold in patients with severely impaired hepatic function (see section 4.2 DOSE AND METHOD OF ADMINISTRATION, section 4.3 CONTRAINDICATIONS and section 4.4 SPECIAL WARNINGS AND PRECAUTIONS FOR USE).

5.3 PRECLINICAL SAFETY DATA

General

Chronic toxicity studies in rat and dog of the vehicle used for Buvidal Monthly revealed no specific special hazard for humans.

Genotoxicity

Buprenorphine has been shown to give negative results in mutagenicity and clastogenicity assays. Similarly, the other components of Buvidal Monthly have either been shown to lack in vitro mutagenic and clastogenic activity (i.e. glyceryl dioleate, and N-methylpyrrolidone) or are generally recognised as safe (i.e. phosphatidyl choline).

Carcinogenicity

Buprenorphine and the other components of Buvidal Monthly are considered to have low carcinogenic potential.

6 PHARMACEUTICAL PARTICULARS

6.1 LIST OF EXCIPIENTS

phosphatidyl choline [soybean],
glyceryl dioleate
N-methyl-2-pyrrolidone

6.2 INCOMPATIBILITIES

This product must not be mixed with other medicinal products.

6.3 SHELF LIFE

In Australia, information on the shelf life can be found on the public summary of the Australian Register of Therapeutic Goods (ARTG). The expiry date can be found on the packaging.

6.4 SPECIAL PRECAUTIONS FOR STORAGE

Store below 25°C
Do not refrigerate or freeze

6.5 NATURE AND CONTENTS OF CONTAINER

Buvidal Monthly injection solution for subcutaneous administration is supplied as a single dose in a 1 ml pre-filled syringe (glass) with plunger stopper (fluoropolymer-coated bromobutyl rubber) with needle (½-inch, 23 gauge, 12 mm) and needle shield (styrene butadiene rubber). The filled syringe is assembled in a safety device for post-injection needlestick prevention.

Each pack contains a single (1) prefilled syringe in the following strengths:

Pre-filled syringe containing 64 mg buprenorphine in 0.18 ml solution
Pre-filled syringe containing 96 mg buprenorphine in 0.27 ml solution
Pre-filled syringe containing 128 mg buprenorphine in 0.36 ml solution
Pre-filled syringe containing 160 mg buprenorphine in 0.45 ml solution

6.6 SPECIAL PRECAUTIONS FOR DISPOSAL

In Australia, any unused medicinal product or waste material should be disposed of in accordance with local requirements.

Other information:

- Do not use if the safety syringe is broken or the packaging is damaged.
- The needle cap of the safety syringe may contain rubber latex that may cause allergic reactions in latex sensitive individuals.
- Handle the safety syringe carefully to avoid a needle stick injury. The safety syringe includes a needle protection safety device that will activate at the end of the injection. The needle protection will help to prevent needle stick injuries.
- Do not uncap the safety syringe until you are ready to inject. Once uncapped never try to recap the needle.
- Dispose of the used safety syringe immediately after use. Do not re-use the safety syringe.

ADMINISTRATION INSTRUCTIONS FOR HEALTHCARE PROFESSIONALS

Before administration

Safety syringe parts:

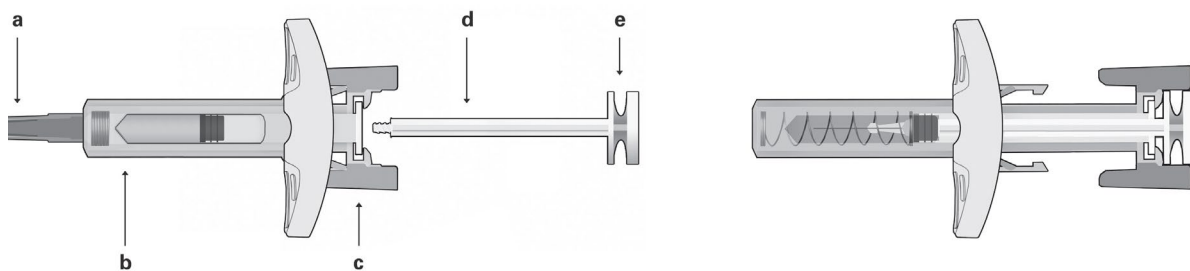

Figure 1 : Safety Syringe; Before use:
a) Needle shield, b) Syringe Guard Body,
c) Syringe Guard Wings, d) Plunger,
e) Plunger Head

Safety Syringe: After use
(With needle protection mechanism activated)

Please note that the smallest injection volume is barely visible in the viewing window as the spring of the safety device is “covering” part of the glass cylinder close to the needle

Do not touch the syringe guard wings until you are ready to inject to avoid premature activation of the syringe guard.

Do not use the product if it has been dropped on a hard surface or damaged. Discard the damaged syringe and use a new product for the injection.

Administration

- Take the syringe out of the cardboard box: pick up the syringe by the syringe guard body.
- While holding a firm grip on the syringe by the syringe guard body, insert the plunger rod into the plunger stopper by gently rotating the plunger rod clockwise until secured (see Figure 2).

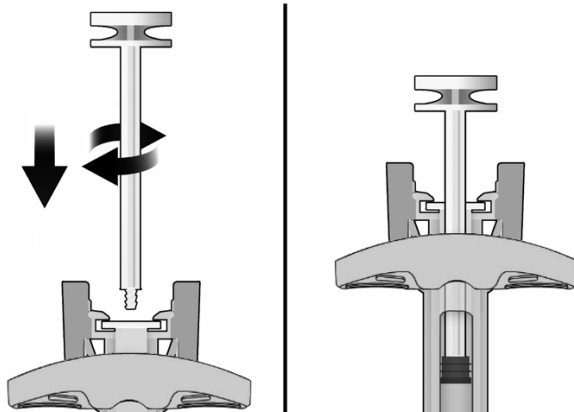

Figure 2: Before

After

- Inspect the safety syringe closely:
- Do not use the safety syringe after the expiration date shown on the cardboard box or on the syringe label.
- A small air bubble may be seen, which is normal.
- The liquid should be clear. Do not use the safety syringe if the liquid contains visible particles or is cloudy.
- Choose the injection site. Injections should be rotated and alternated between sites in the buttock, thigh, abdomen, or upper arm (see Figure 3). Injections on the waistline or within 5 cm of the navel should be avoided.

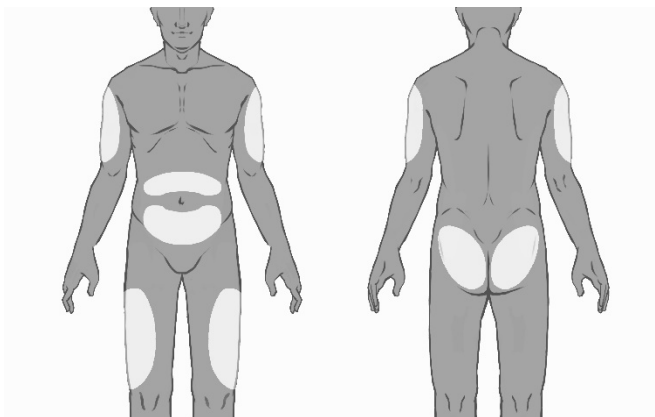

Figure 3:

- Put on gloves and clean the injection site with a circular motion using an alcohol wipe (not provided in the pack). Do not touch the cleaned area again before injecting.
- While holding the safety syringe by the syringe guard body as shown (see Figure 4), carefully pull the needle cap straight off. Immediately dispose of the needle cap (never try to recap the needle). A drop of liquid may be seen at the end of the needle. This is normal.

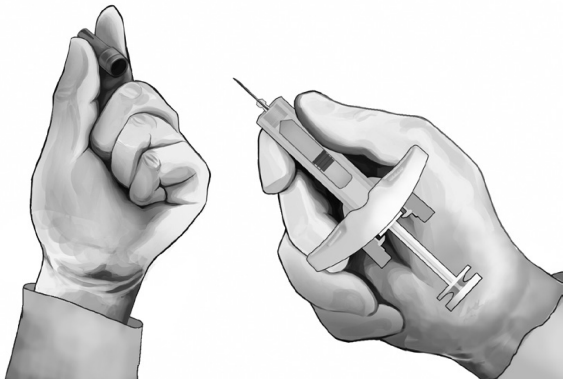

Figure 4

- Pinch the skin at the injection site between the thumb and finger as shown (see Figure 5).
- Hold the safety syringe as shown and insert the needle at an angle of approximately 90° (see Figure 5). Push the needle all the way in.

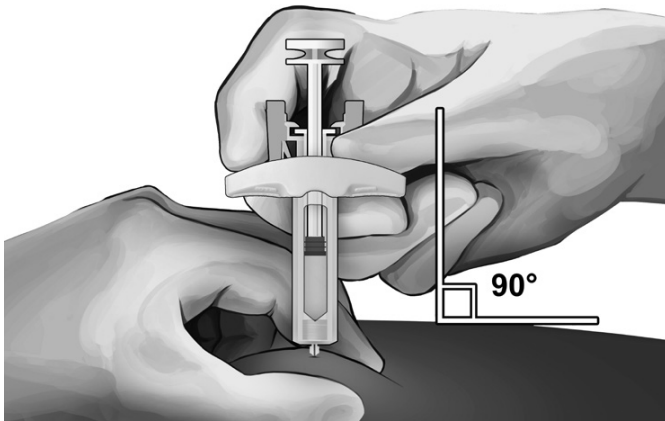

Figure 5

- While holding the syringe as shown (see Figure 6), slowly depress the plunger until the plunger head latches between the syringe guard wings and all the solution is injected.

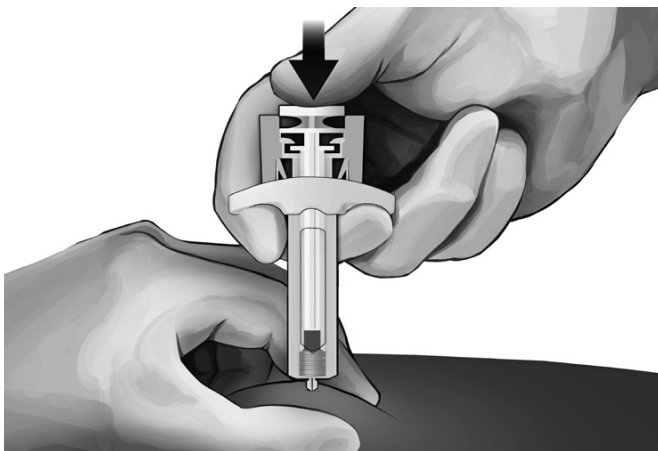

Figure 6

- Gently pull the needle out of the skin. It is recommended that the plunger is kept fully depressed while the needle is carefully lifted straight out from the injection site (see Figure 7).

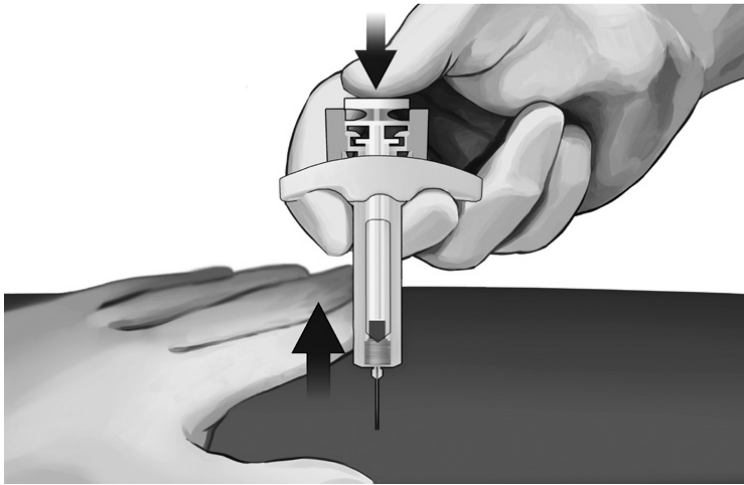

Figure 7

- As soon as the needle has been completely removed from the skin, slowly take the thumb off the plunger and allow the syringe guard to automatically cover the exposed needle (see Figure 8). There may be a small amount of blood at the injection site, if required wipe with a cotton ball or gauze.



Figure 8

Disposing of the syringe

Any unused medicinal product or waste material should be disposed of in accordance with local requirements.

6.7 PHYSICOCHEMICAL PROPERTIES

Chemical structure

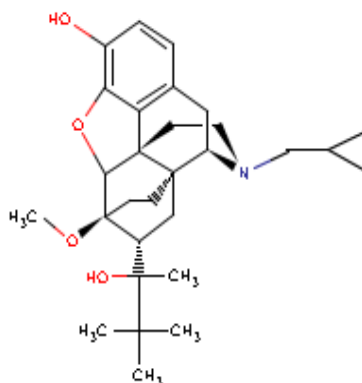

CAS number

52485-79-7

7 MEDICINE SCHEDULE (POISONS STANDARD)

Schedule 8

8 SPONSOR

Camurus Pty Ltd
223 Liverpool St
Darlinghurst, NSW, 2010
Phone Toll Free: 1800 142 038

9 DATE OF FIRST APPROVAL

28 November 2018

10 DATE OF REVISION

19 July 2024

SUMMARY TABLE OF CHANGES

Section Changed	Summary of new information
4.4 Special warnings and precautions for use	<p>Addition of text that dose must not be administered intramuscularly.</p> <p>Addition of statement regarding management of acute pain in patients with opioid dependence.</p> <p>Clarification that dose adjustment may be required in patients with moderate hepatic impairment.</p>

4.5 Interactions with other medicines and other forms of interactions	Addition of examples of gabapentinoids.
6.6 Special precautions for disposal	Update to the instructions for use.